

C3D06065A–silicon Carbide Schottky Diode

Z-REC™ RECTIFIER

V_{RRM}	= 650 V
$I_{F(AVG)}$	= 6 A
Q_c	= 16 nC

Features

- 650-Volt Schottky Rectifier
- Zero Reverse Recovery Current
- Zero Forward Recovery Voltage
- High-Frequency Operation
- Temperature-Independent Switching Behavior
- Extremely Fast Switching
- Positive Temperature Coefficient on V_F

Benefits

- Replace Bipolar with Unipolar Rectifiers
- Essentially No Switching Losses
- Higher Efficiency
- Reduction of Heat Sink Requirements
- Parallel Devices Without Thermal Runaway

Applications

- Switch Mode Power Supplies
- Power Factor Correction
 - Typical PFC P_{out} : 600W-1200W
- Motor Drives
 - Typical Power : 2HP-3HP

Package

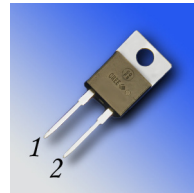

TO-220-2



Part Number	Package	Marking
C3D06065A	TO-220-2	C3D06065

Maximum Ratings

Symbol	Parameter	Value	Unit	Test Conditions	Note
V_{RRM}	Repetitive Peak Reverse Voltage	650	V		
V_{RSM}	Surge Peak Reverse Voltage	650	V		
V_{DC}	DC Blocking Voltage	650	V		
$I_{F(AVG)}$	Average Forward Current	6	A	$T_c=150^\circ\text{C}$, DC	
I_{FRM}	Repetitive Peak Forward Surge Current	41 27	A	$T_c=25^\circ\text{C}$, $t_p = 10$ ms, Half Sine Wave, $D=0.3$ $T_c=110^\circ\text{C}$, $t_p=10$ ms, Half Sine Wave, $D=0.3$	
I_{FSM}	Non-Repetitive Peak Forward Surge Current	70 55	A	$T_c=25^\circ\text{C}$, $t_p = 10$ mS, Half Sine Wave, $D=0.3$ $T_c=110^\circ\text{C}$, $t_p = 10$ mS, Half Sine Wave, $D=0.3$	
I_{FSM}	Non-Repetitive Peak Forward Surge Current	200	A	$T_c=25^\circ\text{C}$, $t_p = 10$ μs , Pulse	
P_{tot}	Power Dissipation	79 34	W	$T_c=25^\circ\text{C}$ $T_c=110^\circ\text{C}$	
T_j, T_{stg}	Operating Junction and Storage Temperature	-55 to +175	$^\circ\text{C}$		
	TO-220 Mounting Torque	1 8.8	Nm lbf-in	M3 Screw 6-32 Screw	

Electrical Characteristics

Symbol	Parameter	Typ.	Max.	Unit	Test Conditions	Note
V_F	Forward Voltage	1.6 1.9	1.8 2.4	V	$I_F = 6\text{ A}$ $T_J = 25^\circ\text{C}$ $I_F = 6\text{ A}$ $T_J = 175^\circ\text{C}$	
I_R	Reverse Current	12 24	60 220	μA	$V_R = 650\text{ V}$ $T_J = 25^\circ\text{C}$ $V_R = 650\text{ V}$ $T_J = 175^\circ\text{C}$	
Q_C	Total Capacitive Charge	16		nC	$V_R = 650\text{ V}$, $I_F = 6\text{ A}$ $di/dt = 500\text{ A}/\mu\text{s}$ $T_J = 25^\circ\text{C}$	
C	Total Capacitance	294 27 26		pF	$V_R = 0\text{ V}$, $T_J = 25^\circ\text{C}$, $f = 1\text{ MHz}$ $V_R = 200\text{ V}$, $T_J = 25^\circ\text{C}$, $f = 1\text{ MHz}$ $V_R = 400\text{ V}$, $T_J = 25^\circ\text{C}$, $f = 1\text{ MHz}$	

Note:

1. This is a majority carrier diode, so there is no reverse recovery charge.

Thermal Characteristics

Symbol	Parameter	Typ.	Unit
$R_{\theta JC}$	Thermal Resistance from Junction to Case	1.6	$^\circ\text{C}/\text{W}$

Typical Performance

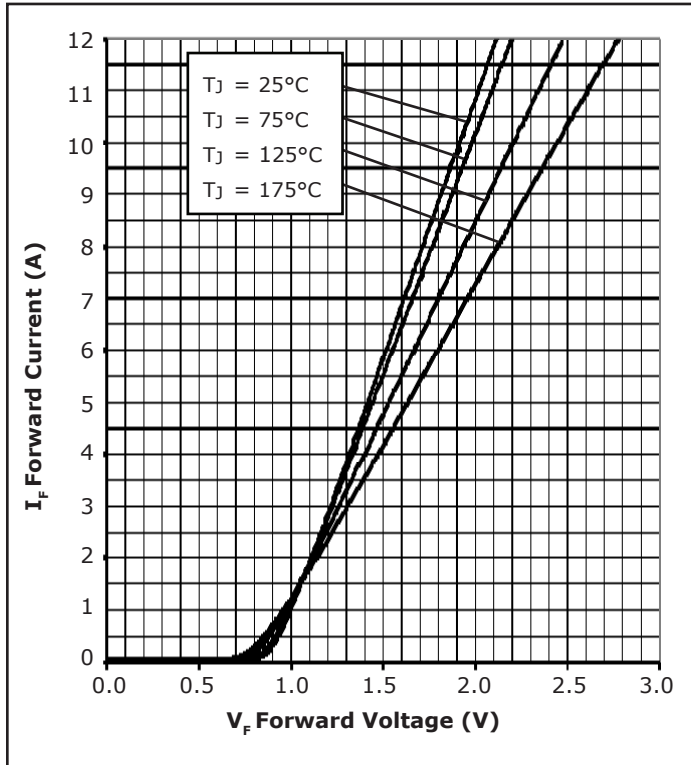

Figure 1. Forward Characteristics

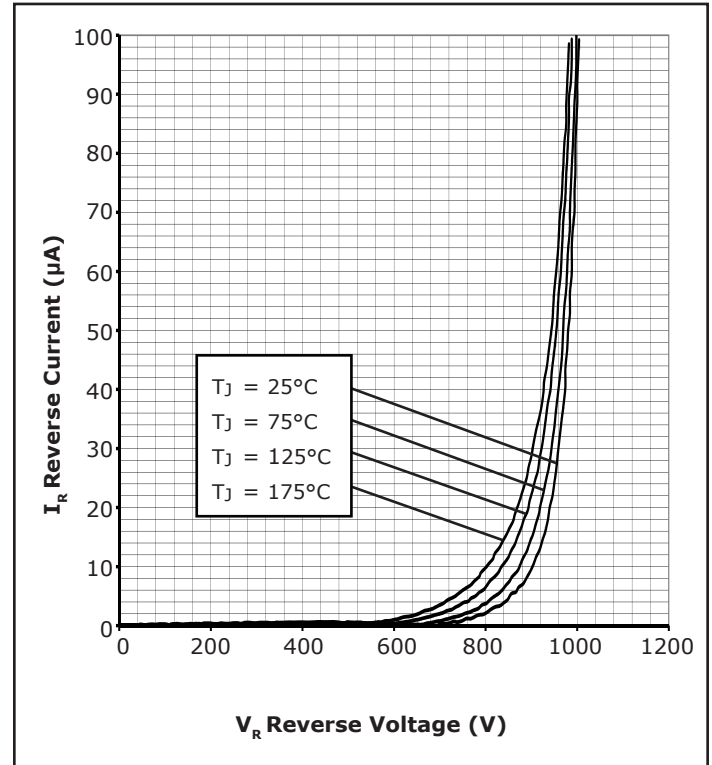

Figure 2. Reverse Characteristics

Typical Performance

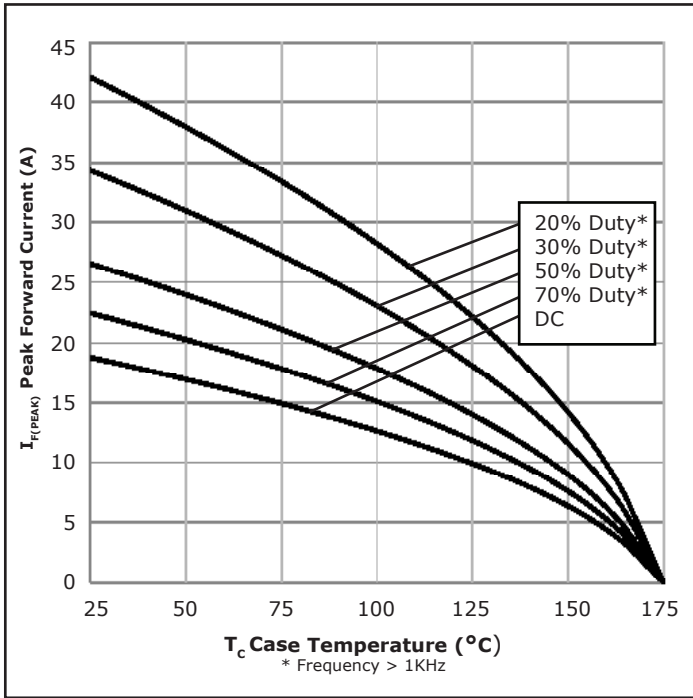

Figure 3. Current Derating

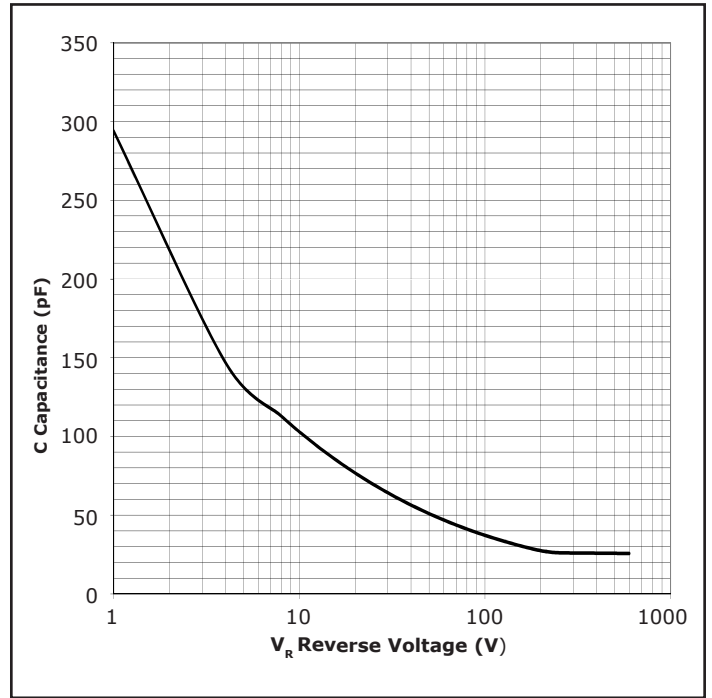

Figure 4. Capacitance vs. Reverse Voltage

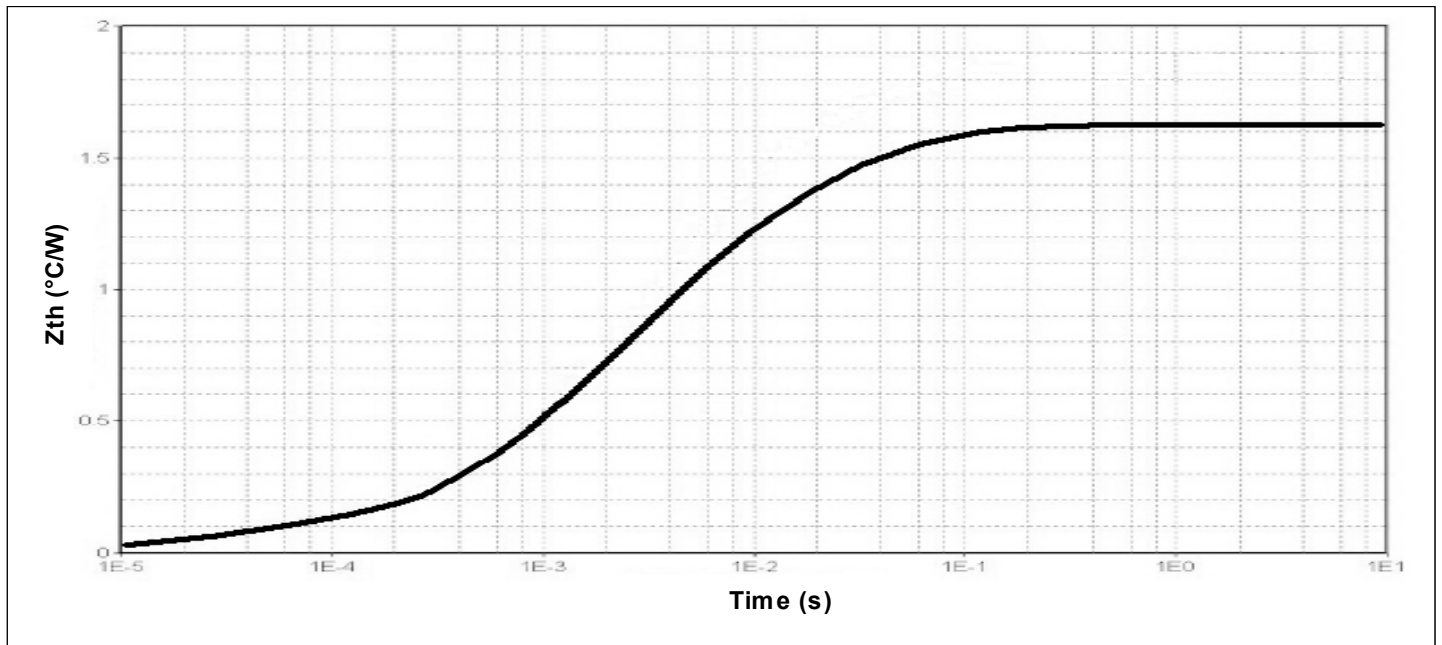

Figure 5. Transient Thermal Impedance

Typical Performance

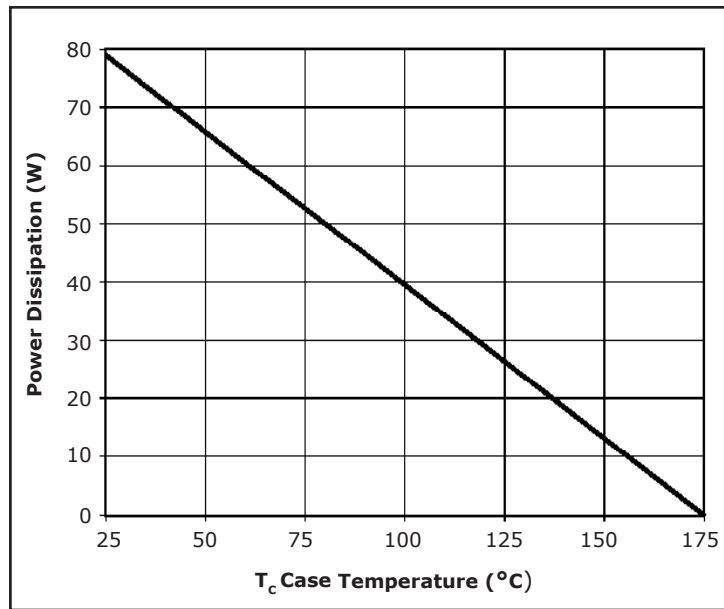
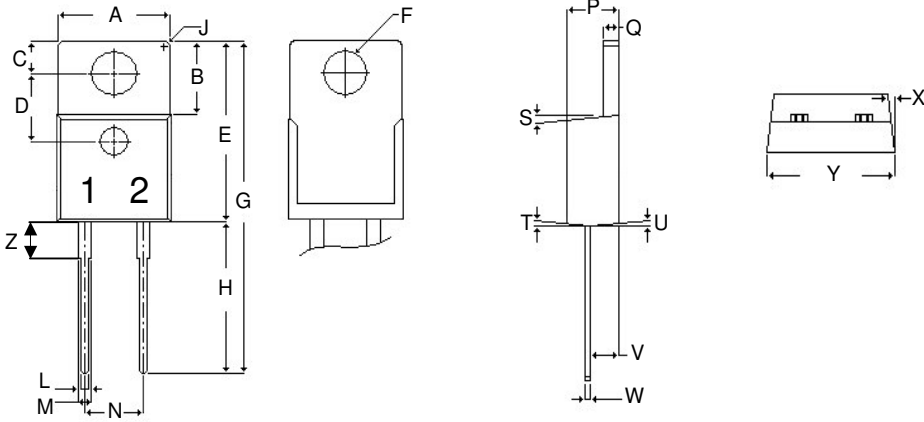

Figure 6. Power Derating

Package Dimensions

Package TO-220-2



POS	Inches		Millimeters	
	Min	Max	Min	Max
A	.381	.410	9.677	10.414
B	.235	.255	5.969	6.477
C	.100	.120	2.540	3.048
D	.223	.337	5.664	8.560
E	.590	.615	14.986	15.621
F	.143	.153	3.632	3.886
G	1.105	1.147	28.067	29.134
H	.500	.550	12.700	13.970
J	R 0.197		R 0.197	
L	.025	.036	.635	.914
M	.045	.055	1.143	1.397
N	.195	.205	4.953	5.207
P	.165	.185	4.191	4.699
Q	.048	.054	1.219	1.372
S	3°	6°	3°	6°
T	3°	6°	3°	6°
U	3°	6°	3°	6°
V	.094	.110	2.388	2.794
W	.014	.025	.356	.635
X	3°	5.5°	3°	5.5°
Y	.385	.410	9.779	10.414
Z	.130	.150	3.302	3.810

NOTE:

1. Dimension L, M, W apply for Solder Dip Finish

Recommended Solder Pad Layout

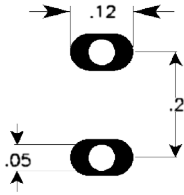

TO-220-2

Part Number	Package	Marking
C3D06065A	TO-220-2	C3D06065

Diode Model

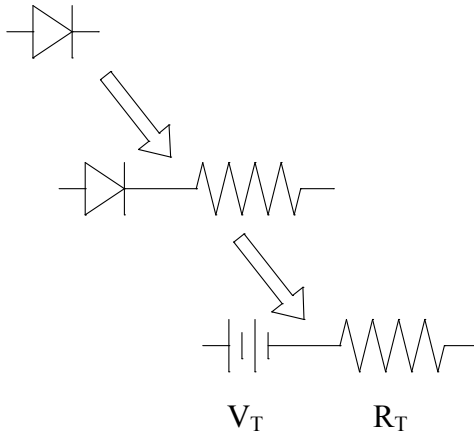

$$V_{fT} = V_T + I_f * R_T$$

$$V_T = 0.975 + (T_j * -1.0 * 10^{-3})$$

$$R_T = 0.09 + (T_j * 0.51 * 10^{-3})$$

Note: T_j = Diode Junction Temperature In Degrees Celcius

"The levels of environmentally sensitive, persistent biologically toxic (PBT), persistent organic pollutants (POP), or otherwise restricted materials in this product are below the maximum concentration values (also referred to as the threshold limits) permitted for such substances, or are used in an exempted application, in accordance with EU Directive 2002/95/EC on the restriction of the use of certain hazardous substances in electrical and electronic equipment (RoHS), as amended through April 21, 2006.

This product has not been designed or tested for use in, and is not intended for use in, applications implanted into the human body nor in applications in which failure of the product could lead to death, personal injury or property damage, including but not limited to equipment used in the operation of nuclear facilities, life-support machines, cardiac defibrillators or similar emergency medical equipment, aircraft navigation or communication or control systems, air traffic control systems, or weapons systems.

Copyright © 2010 Cree, Inc. All rights reserved. The information in this document is subject to change without notice. Cree and the Cree logo are registered trademarks and Z-Rec is a trademark of Cree, Inc.

Cree, Inc.
4600 Silicon Drive
Durham, NC 27703
USA Tel: +1.919.313.5300
Fax: +1.919.313.5451
www.cree.com/power